







# ANTI VINDAL PBM-22 SERIES

## How to Order

PBM - 22 Z22

FUNCTIONS		ACTUATOR TYPE	ACTUATOR COLOR		LED COLOR		LED POLARITY
TYPE	CIRCUIT						
M MOMENTARY	11 SPST  2P	F FLAT	B METAL BLACK ANODIZED	Q BRONZE	N NO LED	<input type="checkbox"/> NO LED	<input type="checkbox"/> NO LED
Z LOCK	12 SPST+ LAMP  2P	R CURVE	S METAL SILVER	O GOLD	R RED	<input type="checkbox"/> NO LED	1 NONE
	13 SPDT  3P	H RAISED	J ROSE GOLD	T STAINLESS STEEL	W WHITE	W WHITE	2 ANODE
	15 SPDT+ LAMP  3P		R RED	X CHAMPAGNE	U BLUE	U BLUE	3 CATHODE
	21 SPDT  4P		U BLUE		G GREEN	G GREEN	4 SINGLE
	22 SPDT+ LAMP  4P		G GREEN		Y YELLOW	Y YELLOW	
23 DPDT+ LAMP  6P		Y YELLOW		O ORANGE	O ORANGE		
					P PINK	P PINK	

LAMP TYPE	LAMP VOLTAGE	BODY MATERIAL	BODY FINISH	TERMINAL TYPE
N NO LAMP	N NONE	B BRASS	8 MIRROR NICKEL PLATED	S SOLDER
S SPOT	3 3V	S STAINLESS STEEL	7 CD PATTERN	
R RING	6 6V	A ALUMINUM	6 BLACK ANODIZED	
E POWER SYMBOL	12 12V		9 CHAMPAGNE	
Q POWER SYMBOL + RING LAMP	24 24V		11 GOLD	
	36 36V		12 ROSE GOLD	
	48 48V			
	110 110V			
	220 220V			

### Nut & Panel Cutout

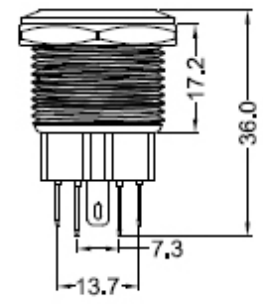
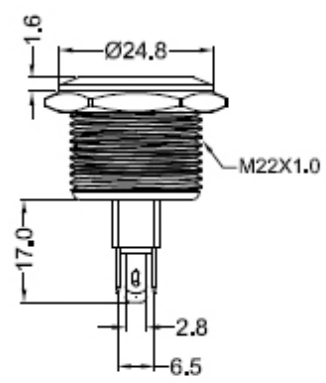
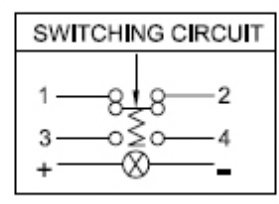
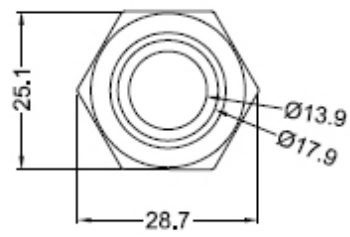
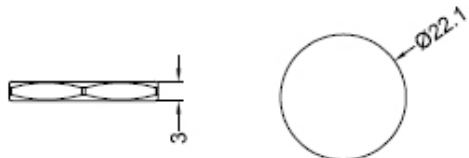

# ANTI VINDAL PBM-22 SERIES



PBM-22M21-FS-N-NN-B8-S

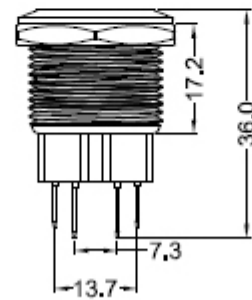
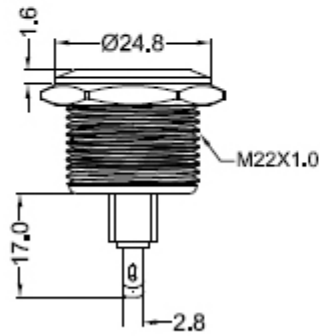
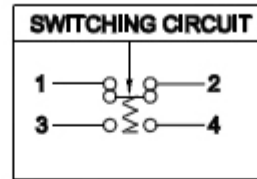
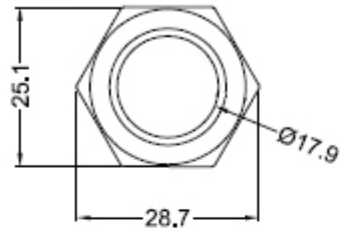

PBM-22M22-FT-R1-S3-S7-S

